















































**GAZELLE S COT**  
**GAZELLE S NACELLE**

	Configurations	6
	Tutorial video	9
	Preparing the carry cot	10
	Attaching the carry cot MONO	14
	Adjusting the seat adapters	16
	Attaching the carry cot DUO	18
	Using the sun canopy	19
	Using the inner pockets	20
	Folding	20
	Using the rain cover	22
	Removing the fabric	24

	Konfigurationen	6
	Videoanleitung	9
	Vorbereitung des Kinderwagenaufsatzes	10
	Anbringung des Kinderwagenaufsatzes	14
	Anpassen der Sitz-Adapter	16
	Anbringung des Kinderwagenaufsatzes DUO	18
	Verwendung des Sonnenverdecks	19
	Verwendung der Innentaschen	20
	Faltung	20
	Verwendung des Regenverdecks	22
	Abnahme des Bezuges	24

	Configurations	6
	Tutoriel vidéo	9
	Préparation de la nacelle	10
	Attacher la nacelle MONO	14
	Régler les adaptateurs de siège	16
	Attacher la nacelle DUO	18
	Utilisation du canopy pare-soleil	19
	Utiliser les poches intérieures	20
	Pliage	20
	Utilisation de l'habillage pluie	22
	Retirer la housse	24

	Configuraciones	6
	Video tutorial	9
	Preparación del capazo	10
	Colocación del capazo	14
	Ajuste de los adaptadores del asiento	16
	Colocación del capazo DÚO	18
	Uso de la capota solar	19
	Uso de los bolsillos interiores	20
	Plegado	20
	Uso de la burbuja de lluvia	22
	Extracción de los tejidos	24

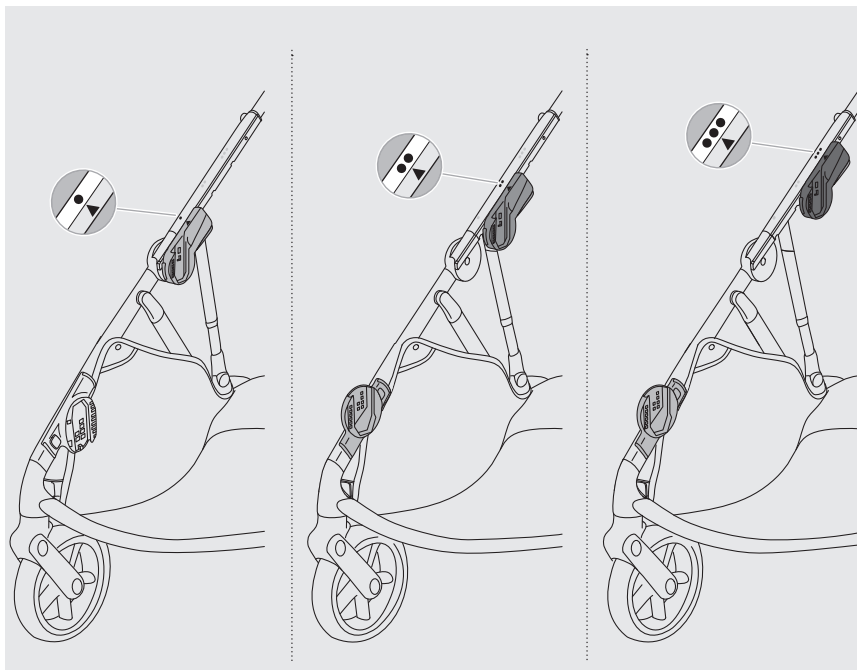



max. 20 lbs/9 kg

max. 25 lbs/11,3 kg

max. 35 lbs/15,9 kg

max. 35 lbs/15,9 kg

max. 50 lbs/22,7 kg







tutorial video  
Videoanleitung  
tutoriel vidéo  
video tutorial

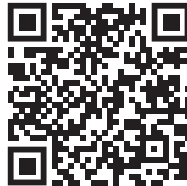

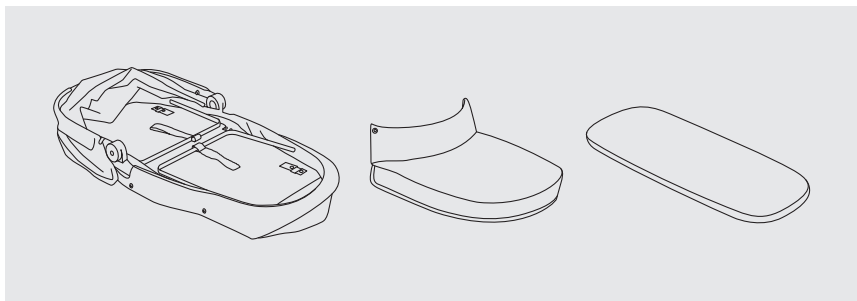

1

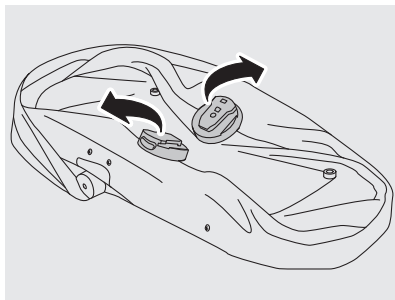

2

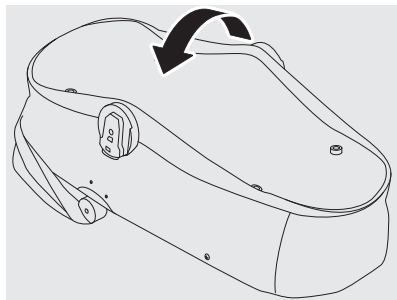

3

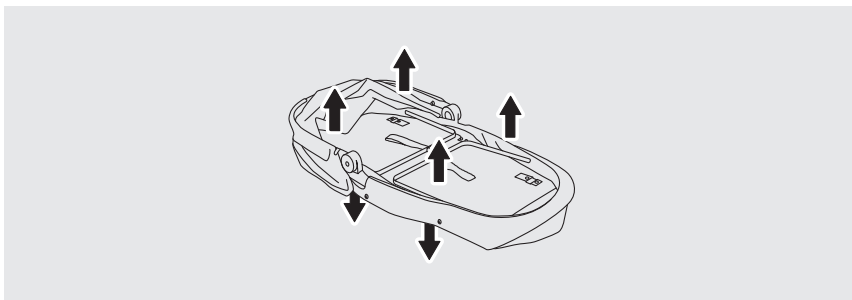

4

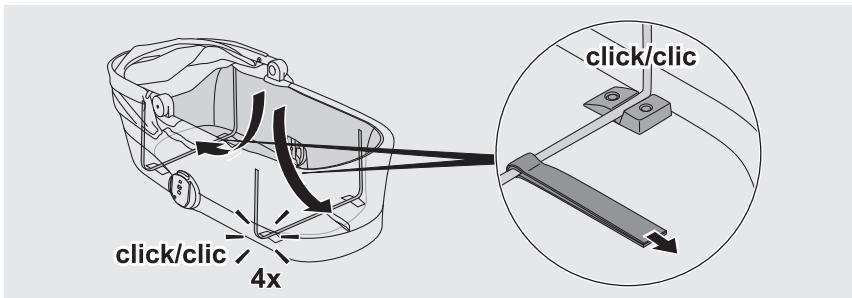

5

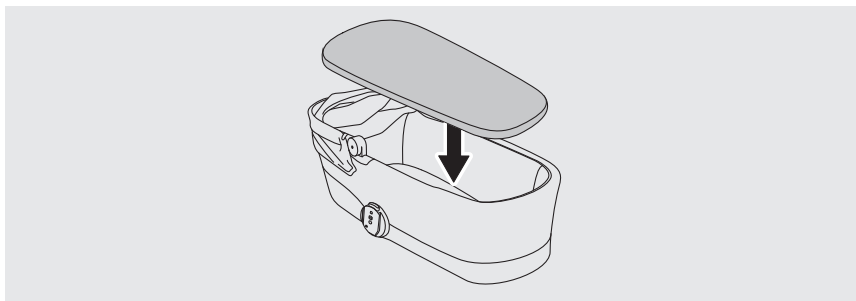

6

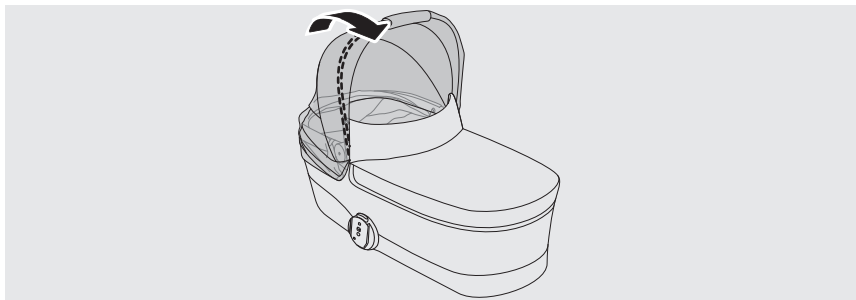

7

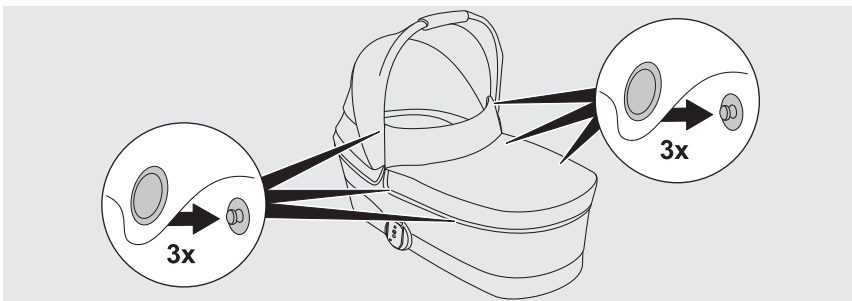

8

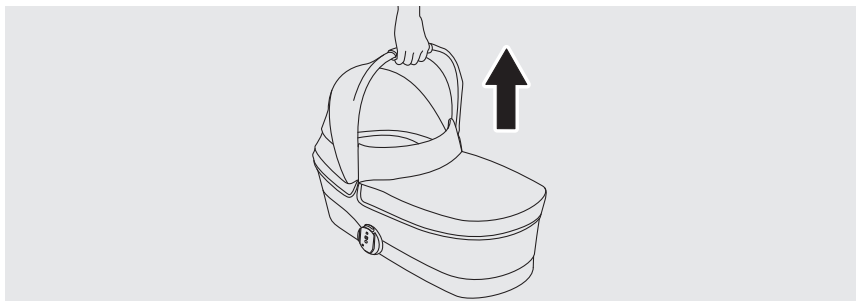

1



2

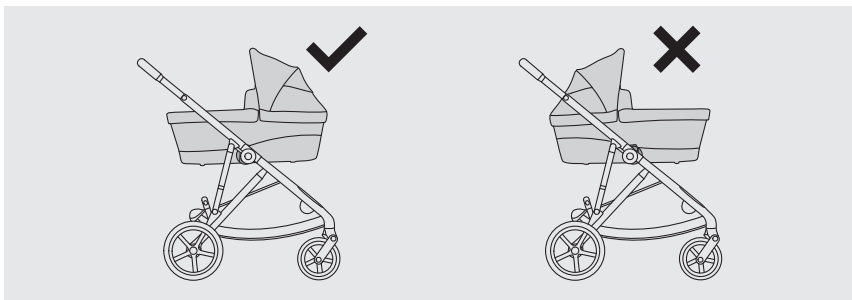

3

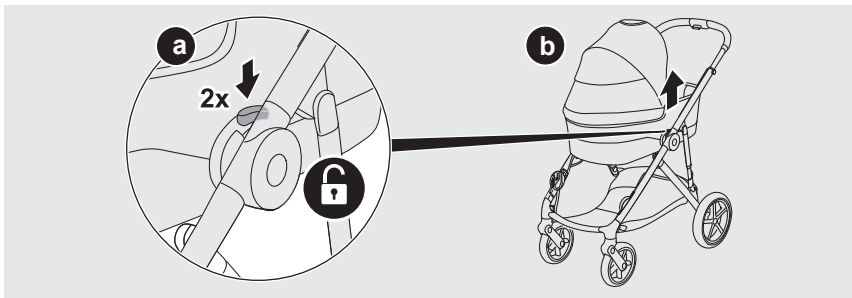

4

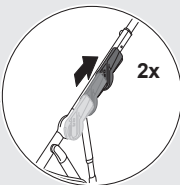
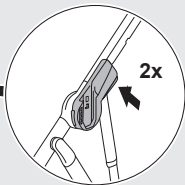

1



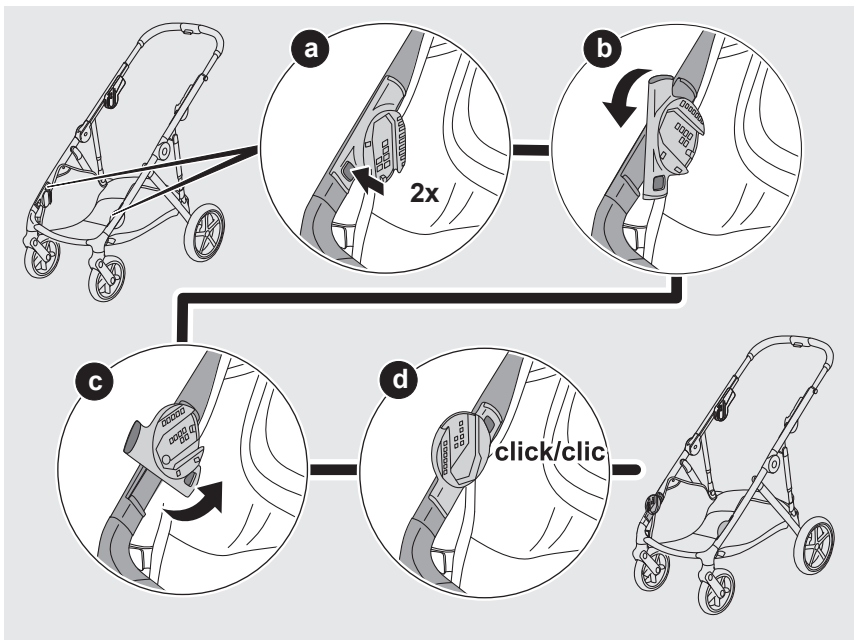

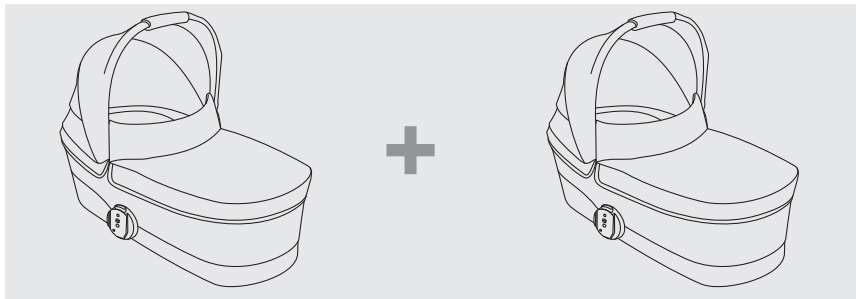

1

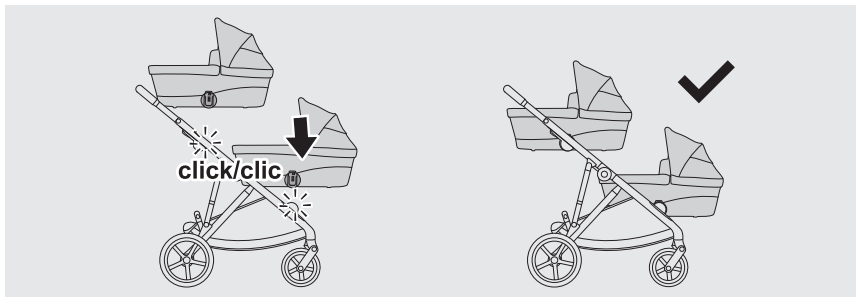

2

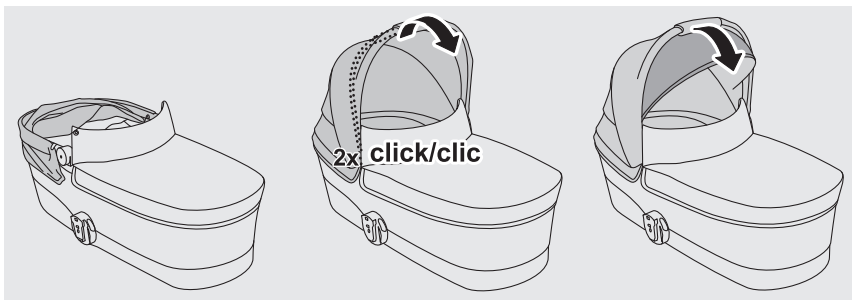

1

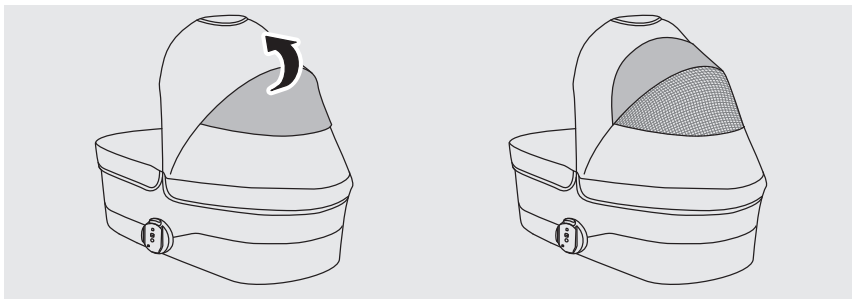

2



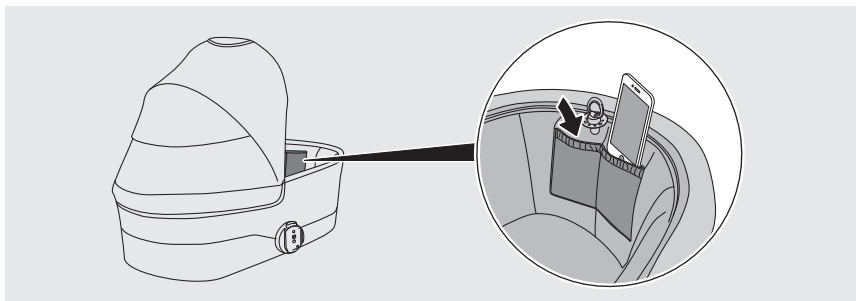

1

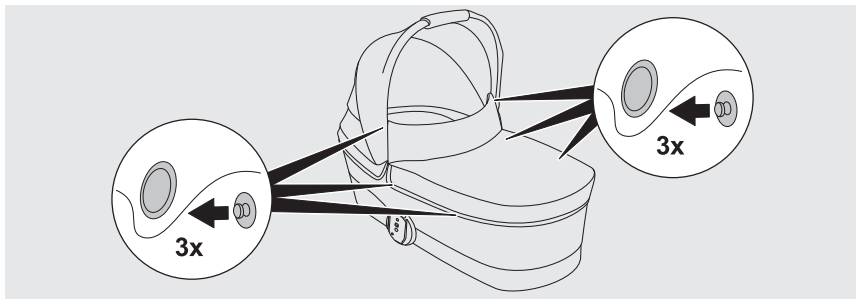

1

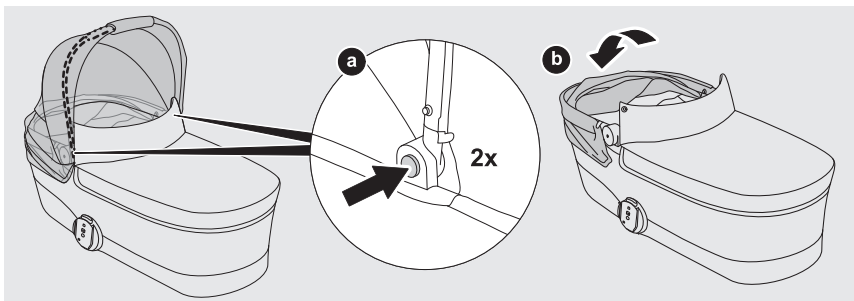

2

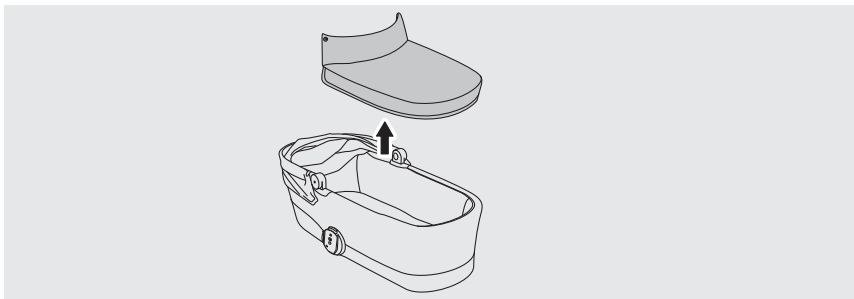

3



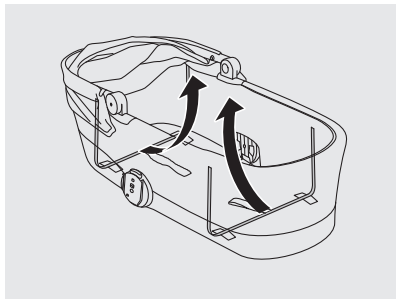

4

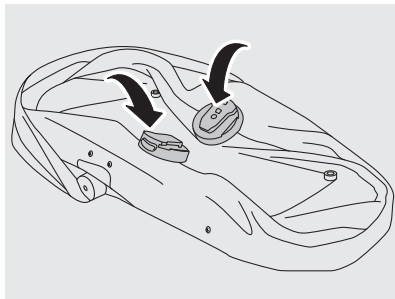

5

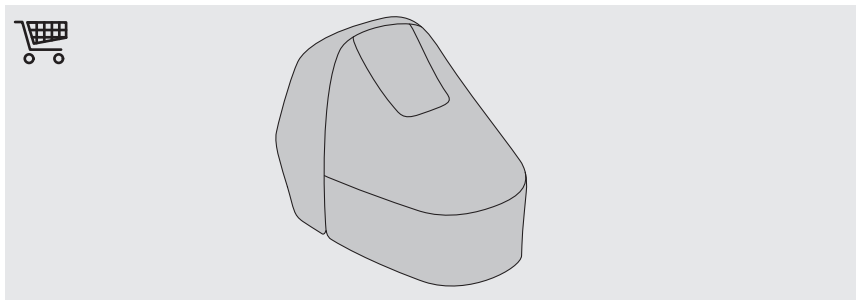

1

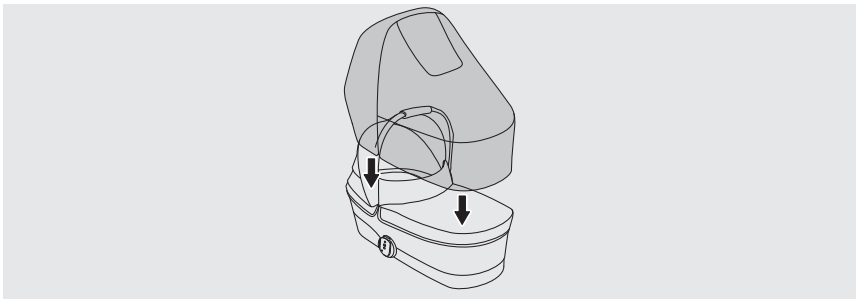

2

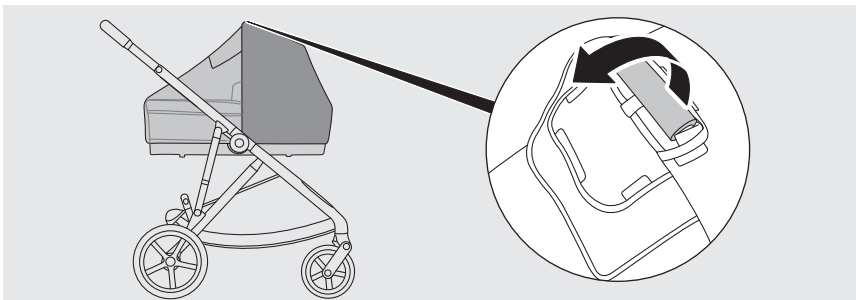

3

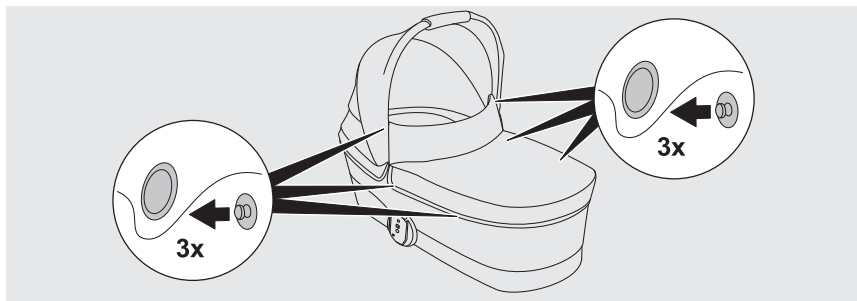

1

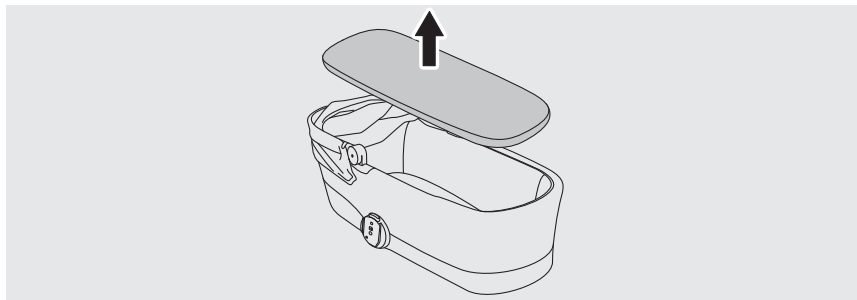

2



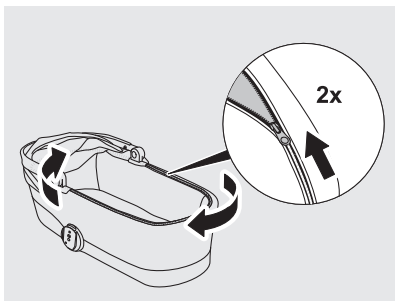

3

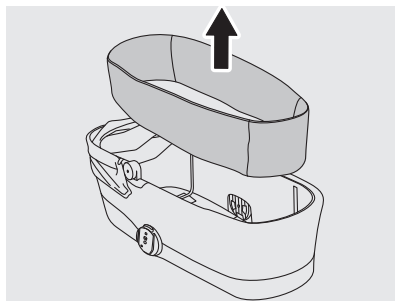

4

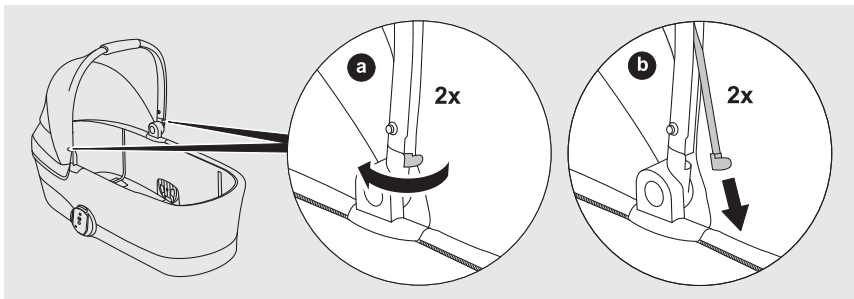

5

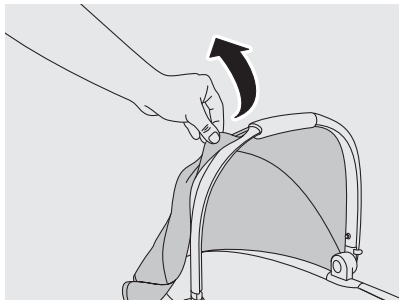

6

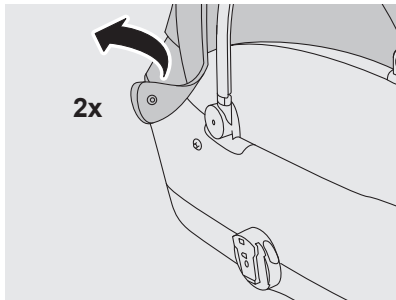

7

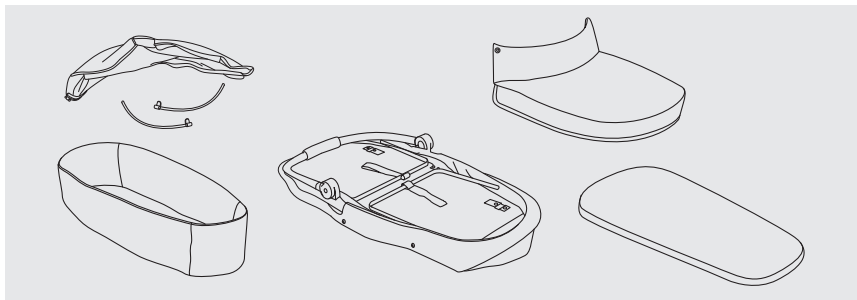





CYBEX GmbH

Riedingerstr. 18 | 95448 Bayreuth | Germany  
+49 (0) 921-78 511-0 | [info@cybex-online.com](mailto:info@cybex-online.com)

AMERICAS

Columbus Trading-Partners USA Inc.  
1801 Commerce Dr. | Piqua, OH 45356 | USA  
Customer Service 1-844-543-2020 | [support.us@columbustp.com](mailto:support.us@columbustp.com)

CANADA

Goodbaby Canada Inc.  
2 Robert Speck Parkway, Suite 750 | Mississauga, ON L4Z 1H8  
Customer Service / Service clients: 1-937-773-3971  
[support.americas@goodbabyint.com](mailto:support.americas@goodbabyint.com)

[www.cybex-online.com](http://www.cybex-online.com)

